

Free eNewsletter

Enter your E-mail



#### Shop By Type

[Cable Assemblies](#)  
[Adapters](#)  
[Connectors](#)  
[Rack Panels](#)  
[Bulk Cable](#)  
[Tools](#)  
[Switch Boxes](#)  
[Network Cards](#)  
[Hubs & Switches](#)  
[Converters & Transceivers](#)  
[KVM Switches](#)  
[Antennas](#)

[Overstock/Sale Items](#)  
[Top 10 Products](#)

#### Shop By Category

[IEEE-488 GPIB](#)  
[Coaxial](#)  
[Monitor, Video](#)  
[Fiber Optic](#)  
[D-Subminiature](#)  
[Modular](#)  
[USB, DIN, Firewire, SCSI, and Others](#)  
[Wireless Infrastructure](#)  
[Weatherproof Enclosures](#)  
[Networking and Other Equipment](#)

#### Product Wizards

[Cable Assemblies](#)  
[Adapters](#)  
[Connectors](#)  
[Rack Panels](#)  
[Tools](#)  
[Switch Boxes](#)  
[Network Cards](#)  
[Hubs or Switches](#)  
[Ethernet Converters](#)  
[KVM Switches](#)

#### Technical Resources

[FAQs](#)  
[Connector Chart](#)  
[Glossary](#)  
[Tutorials](#)  
[Tips and Videos](#)  
[White Papers](#)  
[Catalog Downloads](#)  
[eNewsletter Archive](#)

You Are Here: [Home](#) > [USB, DIN, Firewire, SCSI, and Others](#) > [Adapters, Couplers, Splitters](#) > [ECF504\\_UAB,S](#) > **ECF504-UABS**

## USB A-B Coupler, Shielded

This unique family of USB couplers allow USB cables to be efficiently passed through a panel or enclosure. Furthermore, they are available in many USB connector combinations with your choice of shielded and unshielded housing versions. Unshielded couplers are available in black or ivory and shielded couplers are metallic. Securely mounts via 4-40 screws, must be purchased separately (P/N ECF440). All stock ships same day.







#### Features for this product

- Allows USB cables to be passed through panels or enclosures
- Screw mount for secure installations
- 30 micro inch gold plated contacts provide reliable connections with repeated mating cycles
- Shielded and Unshielded housings available for user grounding preference
- Connector options are USB A-A, B-A & A-B

#### Details for this product

|                               |   |
|-------------------------------|---|
| L-com Item #                  | ECF504-UABS   |
| Manufacturer                  | L-com   |
| ASIN # <a href="#">(More)</a> | B000AAL6US  |
| UPC # <a href="#">(More)</a>  | 822335022515  |
| RoHS Status                   | <a href="#">RoHS Compliant</a>  <a href="#">(More)</a> |
| Color                         | Metallic  |

-  [Diagram](#)
-  [Catalog Page](#)
-  [Catalog Page](#)
-  [2D Drawing \(.pdf\)](#)
-  [3D CAD Model \(.step\)](#)

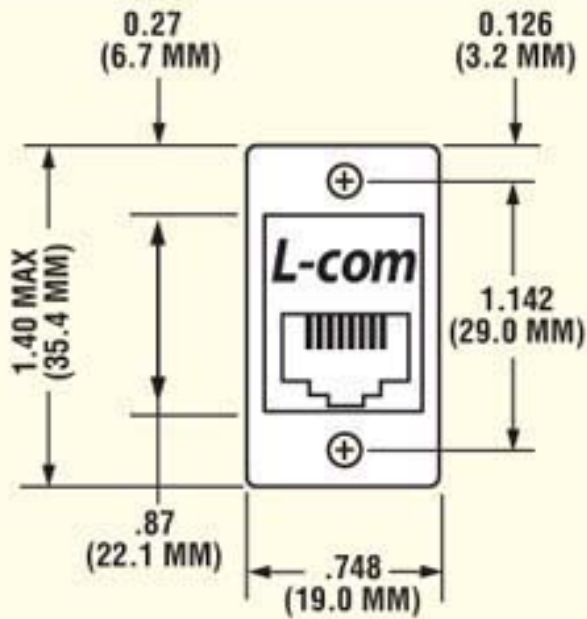

ECF & ECJ Front View

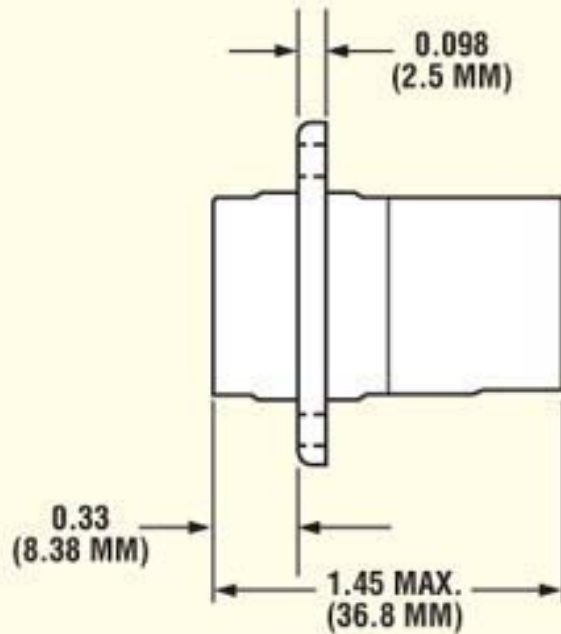

ECF Side View

USB Style Connectors

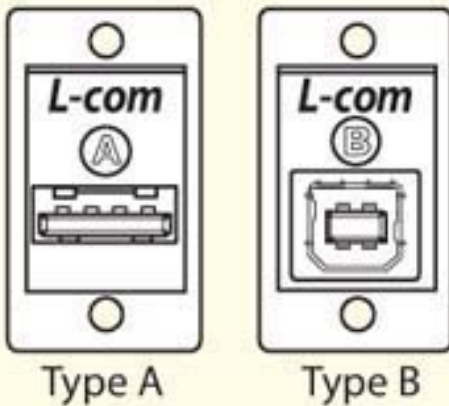

USB Type A & B

ECF & ECJ Series  
RECOMMENDED PANEL  
HOLES

DRILL AND TAP  
HOLES FOR  
4-40 SCREW

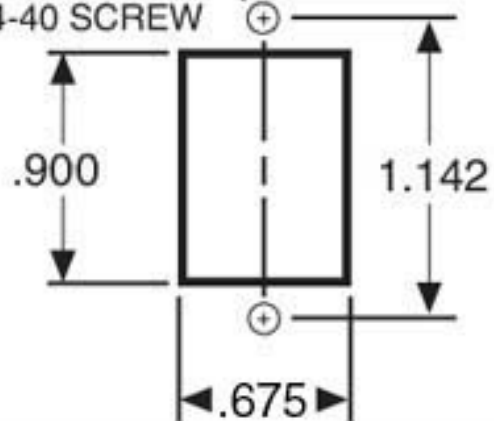

| Item # | Description | Color | 1-9 | 10-24 | 25-99 | 100-249 | 250-499 |
|--------|-------------|-------|-----|-------|-------|---------|---------|
|--------|-------------|-------|-----|-------|-------|---------|---------|

**RoHS Compliant** Panel Mounted USB Type A-B Couplers, 30 Microinches Gold, Colors: Black, Ivory or Silver

These couplers are great for connecting new USB style connectors into panels, etc. One side has Type A connector, the other Type B conforming to requirements. Available in Black, Ivory or Silver. Recommended 4-40 mounting screws must be purchased separately.

|             |                                       |        |  |  |  |  |  |
|-------------|---------------------------------------|--------|--|--|--|--|--|
| ECF504-UAB  | USB Type A - Type B Coupler           | Ivory  |  |  |  |  |  |
| ECF504B-UAB | USB Type A - Type B Coupler           | Black  |  |  |  |  |  |
| ECF504-UABS | USB Type A - Type B Coupler, Shielded | Silver |  |  |  |  |  |
| ECF504-BAS  | USB Type B - Type A Coupler, Shielded | Silver |  |  |  |  |  |
| ECF440      | Machine Screws, 4-40 x 5/16", Pkg/100 |        |  |  |  |  |  |

**RoHS Compliant** USB Type A and B Panel Couplers with 10" Wire Leads, 30 Microinches Gold, Black or Ivory

Similar to our USB coupler except with wire leads in the rear to connect to equipment. Choose from USB Type A or B jacks in Black or Ivory color. Wires are 20 AWG (2 power) and 24 AWG (2 signal) stranded wires with additional drain to shield. Recommended 4-40 mounting screws must be purchased separately.

|            |                                       |       |  |  |  |  |  |
|------------|---------------------------------------|-------|--|--|--|--|--|
| ECJ504-UA  | USB Type A Jack, 10" Leads            | Ivory |  |  |  |  |  |
| ECJ504-UB  | USB Type B Jack, 10" Leads            | Ivory |  |  |  |  |  |
| ECJ504B-UA | USB Type A Jack, 10" Leads            | Black |  |  |  |  |  |
| ECJ504B-UB | USB Type B Jack, 10" Leads            | Black |  |  |  |  |  |
| ECF440     | Machine Screws, 4-40 x 5/16", Pkg/100 |       |  |  |  |  |  |

**RoHS Compliant** IEEE-1394 Firewire Shielded Panel Mount Couplers, Type 1 Connectors

This coupler provides a practical and cost effective way to feed Firewire cables through a panel or enclosure. A unique mounting flange makes these units usable in virtually any panel thickness. Features two Type 1 (6 position) female connectors and metal housing. Recommended 4-40 mounting screws must be purchased separately.

|             |  |        |  |  |  |  |  |
|-------------|--|--------|--|--|--|--|--|
| ECF504-94MS | IEEE-1394 Firewire Shielded Coupler, Type 1 Connectors | Silver |  |  |  |  |  |
| ECF440      | Machine Screws, 4-40 x 5/16", Pkg/100                  |        |  |  |  |  |  |

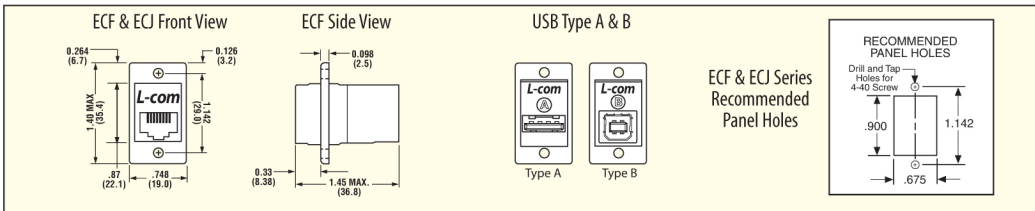

**RoHS Compliant** 19" Panels with 16 or 32 Openings - Pre-Tapped To Accept Any ECF/ECJ504 Adapter

Our 16 and 32 port unpopulated panels are available for those who wish to create their own modular rack panels. Compatible with any of the ECF504 or ECJ504 series couplers on pages 30, 32 and 33. Bone and Black color; pre-tapped screw holes work with 4-40 screws (L-com #ECF440).

|            |  |       |  |  |  |  |  |
|------------|--|-------|--|--|--|--|--|
| PR175F504  | 1.75" Blank Rack Panel accepts 16 Couplers | Bone  |  |  |  |  |  |
| PR35F504   | 3.50" Blank Rack Panel accepts 32 Couplers | Bone  |  |  |  |  |  |
| PR175F504B | 1.75" Blank Rack Panel accepts 16 Couplers | Black |  |  |  |  |  |
| PR35F504B  | 3.50" Blank Rack Panel accepts 32 Couplers | Black |  |  |  |  |  |



**Tip** What is the difference between straight-thru and cross pinning on a modular cable or coupler?

Straight-thru means each contact is straight pinned to its respective contact (1-1, 2-2, 3-3, etc.). Crossed pinning means contacts are pinned through to the opposite contact. Example: On an 8 position RJ45: 1-8, 2-7, 3-6, etc.

When using a coupler between two patch cords it is important to choose the correct type. As the diagrams illustrate, if the desired pinning from end to end is crossed then the coupler and cables must be crossed. For straight pinning, all cables and couplers must be straight-thru type.

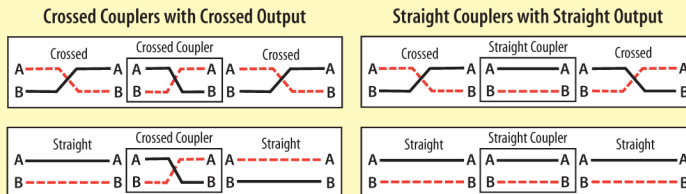

**19" USB Patch Panels - Equipped with 16 or 32 USB A/B Adapters**

An L-com exclusive, four 19" rack panels with 16 or 32 shielded or unshielded USB A/B couplers. Panel heights are 1.75" or 3.5", color is Black with White legends 1-16 or 1-32 imprinted below the couplers. Couplers are Black or Silver (shielded). Additional coupler detail can be found on page 104.

|                |                                       |       |  |  |  |  |  |
|----------------|---------------------------------------|-------|--|--|--|--|--|
| PR175F504-UAB  | 1.75" 16 Port Panel USB A/B           | Black |  |  |  |  |  |
| PR35F504-UAB   | 3.50" 32 Port Panel USB A/B           | Black |  |  |  |  |  |
| PR175F504-UABS | 1.75" 16 Port Panel USB A/B, Shielded | Black |  |  |  |  |  |
| PR35F504-UABS  | 3.50" 32 Port Panel USB A/B, Shielded | Black |  |  |  |  |  |

**3.5" x 19" Firewire (IEEE-1394) Coupler Panel - Equipped with 32 Shielded Firewire Type 1/1 Couplers**

These exclusive rack panels are populated with 32 of our ECF504-94MS fully shielded Firewire couplers featuring Type 1 (6 position) female connectors on each end. Panel is Black with White legend printed 1-32. Panel size is 3.5" x 19".

|               |  |  |  |  |  |  |  |
|---------------|--|--|--|--|--|--|--|
| PR35F504-94MS | 3.50" 32 Port Firewire (IEEE-1394) Panel, Shielded |  |  |  |  |  |  |
|---------------|--|--|--|--|--|--|--|



**Tip** What is the difference between a USB Type A or B connector?

Type A jacks are found on the host and on hubs.  
Type B jacks are found on peripherals.

